

# Installasjons- og programmerings- håndbok

For Somfy io-Motorer til Screen



Stille inn endeposisjoner med en lokal styring (1W sender)  
Manuell justering av endeposisjonene - Motoren er IKKE innstilt av produsenten

## 1 Ta kontroll over motoren

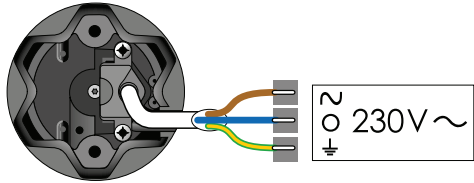

Koble kun 1 motor til strøm (230V)

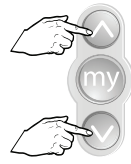

Trykk samtidig  
inntil...



...kort bevegelse

## 2 Sjekk rotasjonsretningen



Trykk kort



OK → trinn 4

eller



ikke OK → trinn 3

## 3 Endre rotasjonsretningen, ved behov

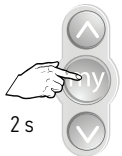

Trykk inntil...



...kort bevegelse → OK  
→ trinn 4

## 4 Sett sluttproduktet i den høyeste posisjonen



## 5 Stille inn øvre endeosisjon



Trykk kort og samtidig på



Produkt går nedover

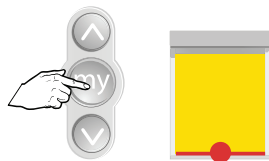

Stopp ved nedre endeosisjon



Juster hvis påkrevd

## 6 Still inn nedre endeosisjon



Trykk kort og samtidig på



Produktet beveger seg oppover



Motoren stopper av seg selv OK

## 7 Bekreft innstillingene

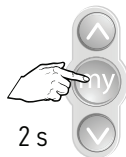

2 s

Trykk inntil...



...kort bevegelse

## 8 Programmere en sender

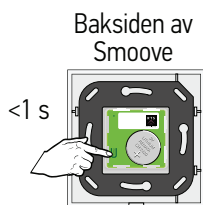

<1 s

Trykk kort på PROG-knappen inntil...



Baksiden av Situo

<1 s



kort bevegelse → OK

Kontroller innstillingene av endeosisjonene

## Endre en innstilt øvre endeveisposisjon med en Situo 1 io



Send produkt til øvre endeveisposisjon

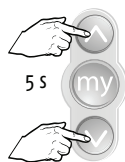

Trykk samtidig inntil...kort bevegelse



Justering av øvre endeveisposisjon

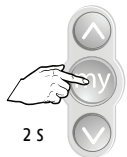

Trykk inntil...



...kort bevegelse  
→ OK

## Endre en innstilt nedre endeveisposisjon med en Situo 1 io



Send produktet til nedre endeveisposisjon

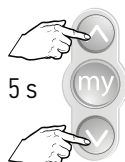

Trykk samtidig inntil...



...kort bevegelse

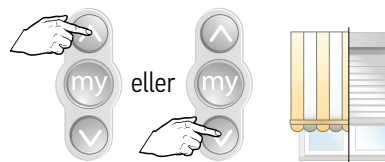

Velg ny nedre endeveisposisjon



Bekreft nedre endeveisposisjon, trykk inntil...



...kort bevegelse  
→ OK

## 1 Slette innstillinger og sendere i motoren - mulig med alle io-motorer

Åpne minnet med dobbelt strømkutt

**Merk:** Alle innstillinger (med unntak av tilbakeimpuls-funksjonen) settes tilbake til fabrikkinnstillinger. Sett strøm kun på motoren som skal tilbakestilles. **Ikke bruk sender med tilbagemelding (2-veisstyring).**

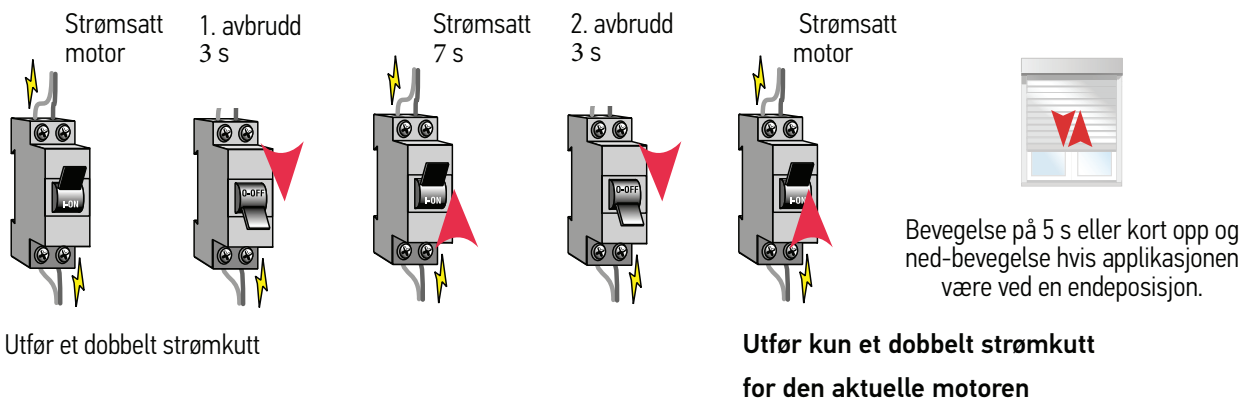

## 2



## Legge til en 1-veisstyring (Situo- eller Smoove-serien)

Allerede programmert  
1-veisstyring

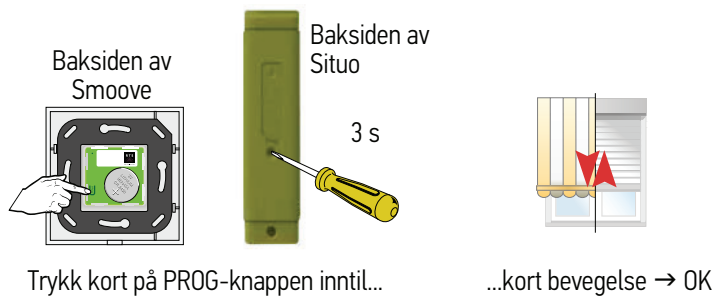

1-veisstyring  
skal legges til

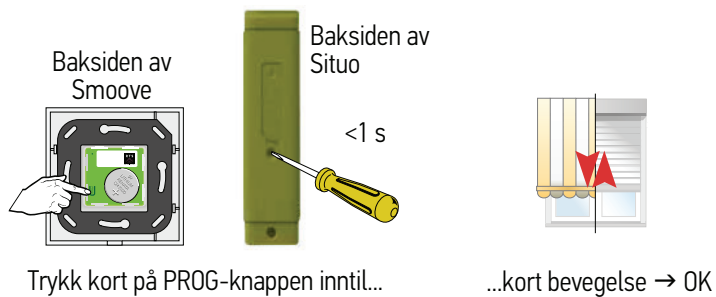

## Slette 1-veisstyring (Situo- eller Smoove-serien)

1-veisstyring  
skal beholdes

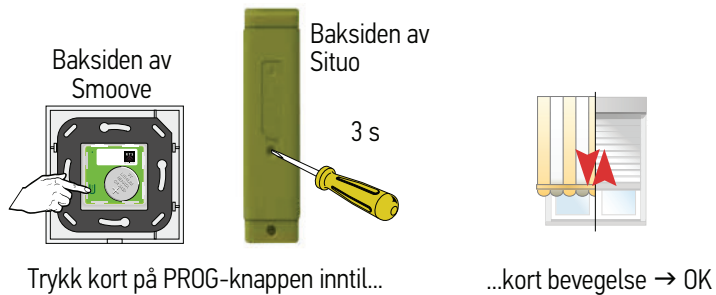

1-veisstyring  
skal slettes

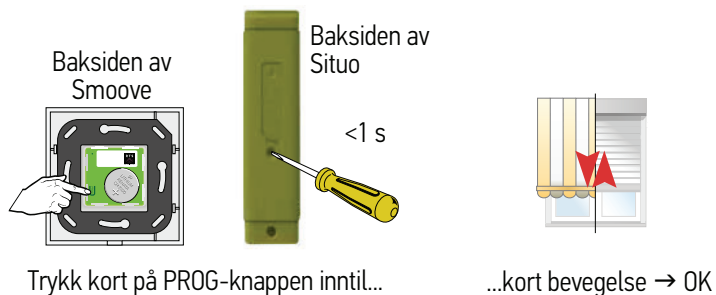

## Erstatte en tapt eller defekt 1-veisstyring

(alle andre 1-veis betjeningsenheter er slettet)

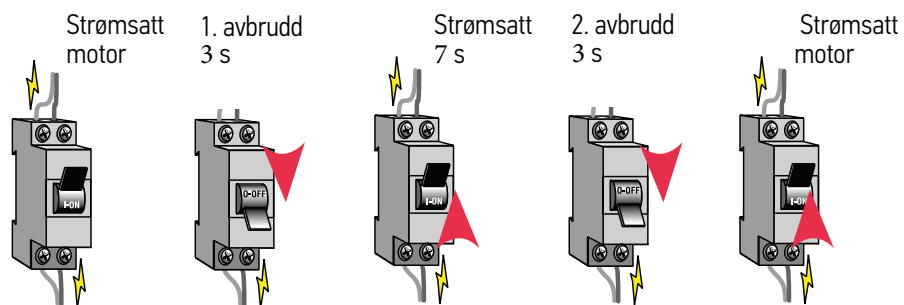

Utfør et dobbelt strømkutt

Bevegelse på 5 s eller kort opp og ned-bevegelse hvis applikasjonen være ved en endeosisjon.

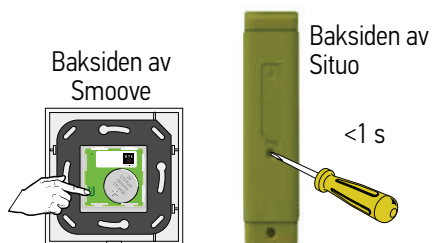

Trykk kort på PROG-knappen inntil...

...kort bevegelse → OK